

PRESS RELEASE

December 22, 2020

Toyota to continue use of our fuel cell gaskets for the new “Mirai”

Sumitomo Riko Company Limited (Headquarters: Nakamura-ku, Nagoya-shi; President & CEO: Kazushi Shimizu) is pleased to announce that the Toyota Motor Corporation (Headquarters: Toyota-shi, Aichi, President: Akio Toyoda) will continue to use our “fuel cell gaskets” in the new fuel cell electric vehicle (FCEV) “Mirai” released on December 9, 2020. The fuel cell gasket is a rubber seal component used for fuel cell (FC) stack and it has been improved both in quality and performance from the previous product used in the first model released in 2014. It also has been significantly improved for mass production, is safer and helps make FCEVs more comfortable.

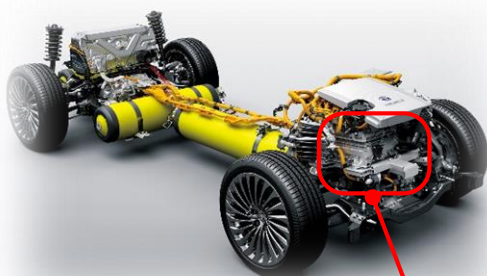

Cell cross-section

Fuel cell gaskets

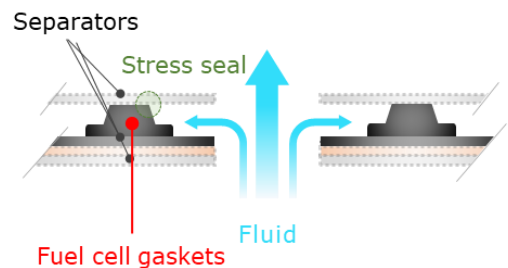

FC Stacks

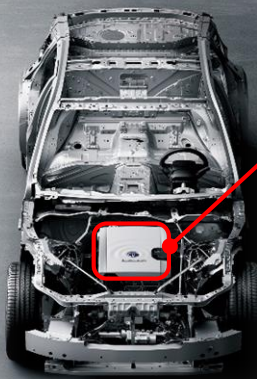

The New Mirai

FCEVs are powered by electricity generated by a chemical reaction created by combining the hydrogen and the oxygen from air in the FC stack. Known as the ultimate eco-car, FCEVs are environmentally friendly vehicles which only produce water and do not emit any carbon dioxide, one of the main greenhouse gases contributing to global warming.

The fuel cell gasket adopted by Toyota in its new Mirai is a rubber seal component that prevents hydrogen, oxygen and water from leaking within the plate-shaped separator and the power components which make up the fuel cell. The FC stack consists of 330 cells, and each cell is equipped with our product.

Furthermore, the fuel cell gasket is a highly effective seal for temperatures ranging from subzero to 100°C or higher. It also enables FCEVs to stay safer for longer and generate power more efficiently.

For this to have once again been selected, we created new material utilizing our core competence, polymer materials technology, and developed a high quality and highly-durable product making full use of the sealant design technology and evaluation technology we created to develop the first model. We also innovated the manufacturing method through the development of materials and greatly reduced the manufacturing process by making high speed molding and other processes possible.

As the new trend known as CASE* emerges in the automotive industry, the government has launched 'Carbon neutrality' policy to effectively achieve zero greenhouse gas emissions by 2050, and thus, the momentum of the electric "E" trend is expected to increase.

As a corporation which strives to be a "company that contributes to safety, comfort, and the environment for people, society, and the earth", the Sumitomo Riko group contributes to a cleaner and more sustainable society and comfortable mobility through our fuel cell gasket, a core component in FCEV.

※ 「C:Connected」 「A:Autonomous」 「S:Shared & Services」 「E:Electric」

<Sumitomo Riko's History of Product Development for FC Stacks>

2000's (First Half)	Commenced development of FC products
2008	Commenced joint development of sealing components with the Toyota Motor Corporation
December 2014	<Toyota releases the FCEV Mirai (first model)> Fuel cell gaskets used in Mirai
April 2015	SumiRiko FC Seal, Ltd. established to manufacture and sell FC components (Komaki-shi, Aichi)
December 2020	<Toyota releases the new Mirai> Fuel cell gaskets readopted in the new Mirai

<Our main components used in the new Mirai>

■ Anti-vibration rubber

(1) FC Stack frame mounts

This is positioned in the part which connects the frame holding the FC stack case and the body, and helps reduce vibration from the air compressor and the vehicle body.

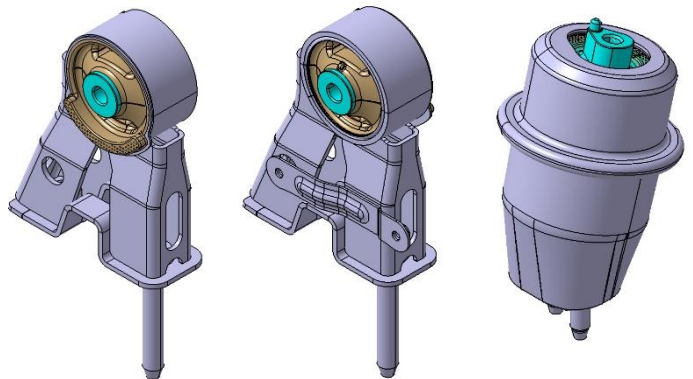

(2) Regulator mounts

This attaches to the hydrogen pressure reduction valve and it helps reduce vibration from the valve.

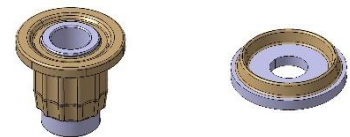

(3) Hydrogen tank mounts

This is installed to secure the hydrogen tank to the body section and it helps reduce vibration from the tank valve.

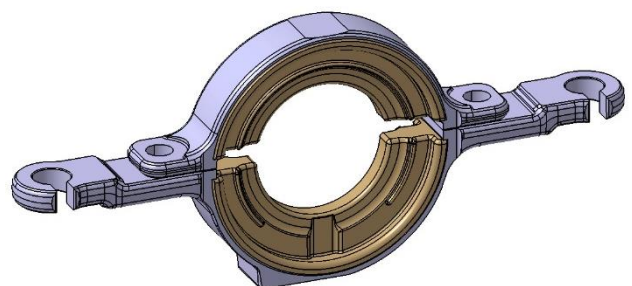

(4) Air compressor mounts

This supports the air compressor which supplies air to the FC stack and it helps reduce vibration from the compressor.

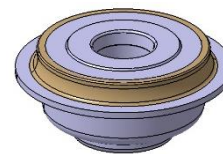

■ Hoses

(1) Hydrogen Hoses

This hose supplies the hydrogen stored in the hydrogen tank to the FC stack and responds to the extremely high level seal required to stop small hydrogen particles.

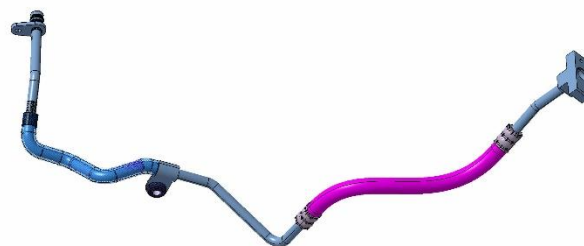

(2) Air Hoses

This hose supplies the oxygen in the air compressed by the air compressor to the FC stack. It is produced in a process where contamination control so as not to inhibit the reaction with the hydrogen.

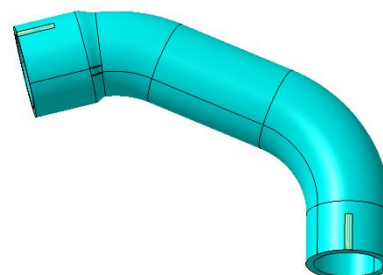

(3) FC Cooling Hoses

This hose is used for the cooling to stabilize the electricity generated by the FC. It is made of a high electrical resistant rubber material and increase the safety of the generated electricity.

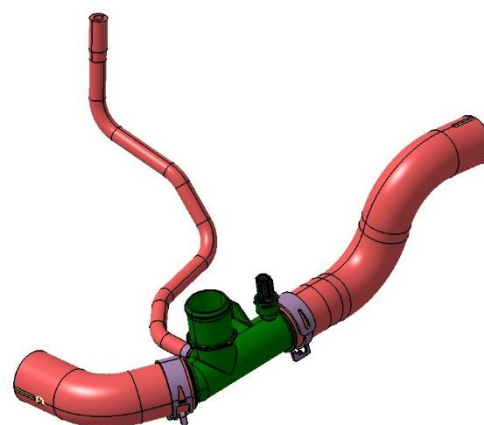

Contact Information
Sumitomo Riko Company Limited
Public Relations and Investor Relations Department
JP Tower Nagoya 1-1-1, Meieki, Nakamura-ku, Nagoya-shi, Aichi 450-6316, Japan
tel +81-52-571-0259 e-mail product.info@jp.sumitomoriko.com